

OWNERS MANUAL



TABLE OF CONTENTS

WELCOME	1
CERTIFICATION	3
ANATOMY OF THE HANS® DEVICE	4
SCIENCE OF THE HANS® DEVICE	5
VEHICLE PREPARATION	6
USING YOUR HANS® DEVICE	8
MAINTENANCE	11
FREQUENTLY ASKED QUESTIONS	12
GLOSSARY	14

Click this icon to move forward
or back within document





WELCOME

Welcome to the growing number of drivers who make the HANS® device part of their race safety system. You have purchased the best product available to help protect your head and neck from serious injury during accidents in motor vehicle competition. Your HANS® device is the result of years of scientific research and testing as well as real world development in tens of thousands of miles of racing competition.

hans
HEAD AND NECK SUPPORT®

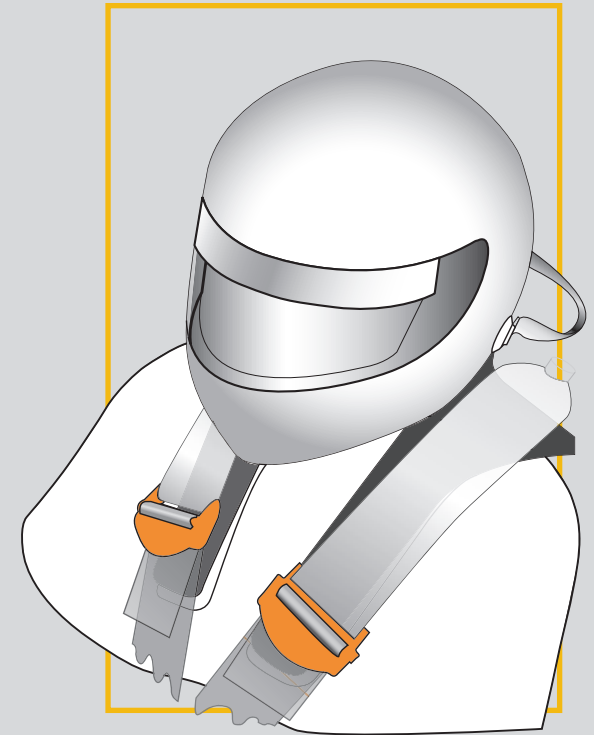

HANS® Performance Products

5096 Peachtree Road

Atlanta, Georgia 30341

U.S.A.

770-457-1046

1-888-HANS-999

www.HANSdevice.com

©2004



GREETINGS FROM THE INVENTORS

From our perspectives as a racecar driver and biomechanical expert, we recognized in the early 1980's that racers were receiving serious head injuries in crashes that might otherwise be injury free. With extensive racing experience, studies in skull bone strength, and data from crash test dummies from which to draw, we designed the HANS® device to function so that when a racer's torso is restrained, the device restrains the head from swinging forward thus greatly reducing neck loads.

We started making and selling HANS® devices in 1990, before the broader racing community really understood much about the biomechanics and significance of head and neck injuries. The first HANS® devices were cumbersome and fit only a limited number of



Jim Downing

Bob Hubbard

drivers and cockpits. In 1997 we started development of the current version. These devices were smaller and lighter, and fit a broad spectrum of racers and cockpits. In both crash sled testing by independent labs and on racetracks around the world, HANS® devices have reduced injuries in accidents.

Many racers credit HANS® with helping them to continue racing and for saving their lives.

In testing and on the track, the HANS® device outperforms any other head and neck restraint.

Thanks for choosing the HANS® device and good luck at the track.

SERIAL NUMBERS AND CERTIFICATION

Your HANS® device has been built to exacting standards, including those of the SFI and FIA. Your device may contain one or both SFI and FIA stickers and/or a bar coded serial number.

DO NOT REMOVE these certification stickers as they will leave a VOID label in their place, voiding your certification. After a large impact you may be asked to remove the certification by a track worker or sanctioning body official.



DO NOT REMOVE these certification stickers as they will leave a VOID label in their place, voiding your certification.



sfi SFI FOUNDATION INC.

This Manufacturer Certifies That This Product Meets

SFI SPEC 38.1

Date of Manufacture		Recertification			
05	06	JAN	APR	JUL	OCT
07	08	FEB	MAY	AUG	NOV
09	10	MAR	JUN	SEP	DEC



ANATOMY OF A HANS[®] DEVICE



- ① Head Pad
- ② Collar
- ③ Tether
- ④ Post Catch
- ⑤ Yoke
- ⑥ Rubber
- ⑦ Yoke Padding



SCIENCE OF THE HANS® DEVICE

Basic Concept: In a crash without a HANS® device, the shoulder harness and seat belt restrain the driver's torso but only the neck restrains the head and helmet. The HANS® device reduces the whipping action of the head; keeping the driver's head from being pulled away from their upper body.

With a HANS®, the forces stretching the neck in a frontal collision are typically reduced by 80%. In a frontal impact the tethers restrain the head's forward movements while the torso and HANS® device are restrained by the shoulder harnesses. By restraining the head to move with the torso in a crash, excessive head motions, neck forces and injuries are dramatically reduced.

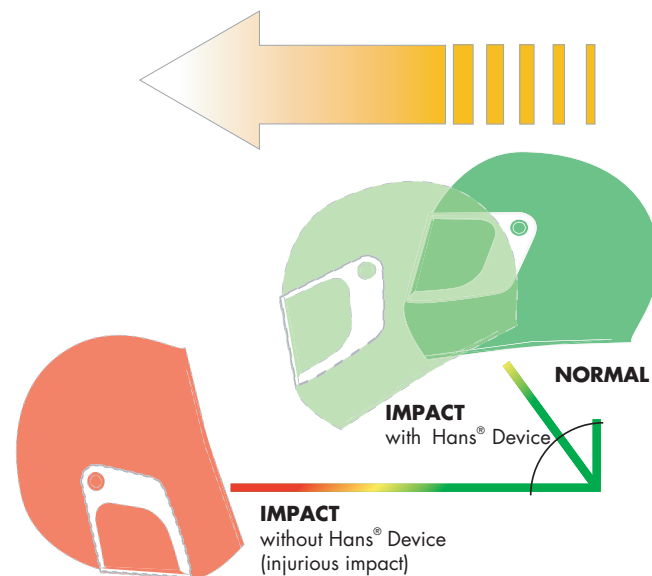

Without HANS® Device



With HANS® Device

Without Hans® Device forward motion is allowed to continue with injurious results.

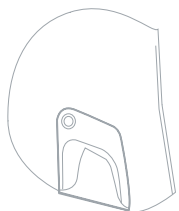

During an impact the Hans® Device stops forward motion before it can reach injurious levels.



Hans® Device at constant speed or at rest allows for ease of movement and visibility.

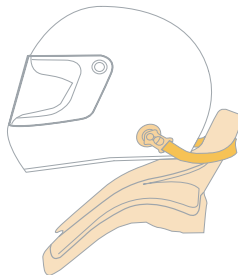

68G Certification Testing for 2004 SFI Specification 38.1 Head and Neck Restraint Systems.

Thanks to Hendrick Motorsports and the Delphi Engineering Center located in Vandalia, Ohio.

In a frontal impact, forward head movements are restrained by tethers while the torso and HANS® device are restrained by the shoulder harnesses.

80% reduction in forward head movement



VEHICLE PREPARATION

SHOULDER BELT MOUNTING

Proper location of the shoulder belt anchoring points is critical. Without the shoulder belts properly mounted the device cannot function as it was designed. Because the HANS® device collar stops the shoulder belts from digging into the user's neck, the harness mounts can be closer together to improve restraint performance and to help keep the shoulder belts securely on the HANS® device.

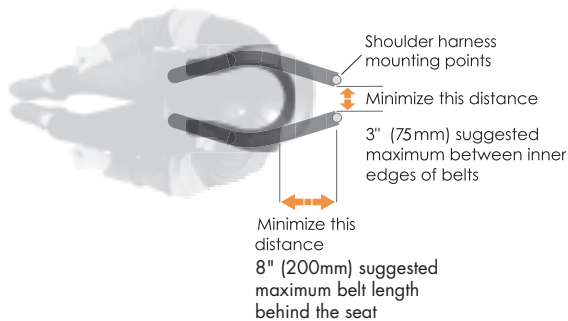

To ensure the belts stay on the HANS® while racing, we recommend the centers of the shoulder belt anchors should be mounted such that the inner edges of the belts are no more than 3 inches (75 mm) apart. Long shoulder belts behind the driver should be avoided; shorter

belts stretch less and as such are safer than longer belts. 8 inches (200mm) is the recommended maximum length of the belts behind the seat and consistent with best practice for shoulder belt mounting.

While restraint and HANS® device performance will be compromised, in the event that a longer belt is necessary, the separation between the belt mounts should be reduced or, preferably, eliminated to keep the belts securely on the HANS® while racing or during an impact. Even if the separation between the belts may be eliminated, it is important to always use a separate anchor for each belt.

Shoulder belts should typically be mounted between 1 and 2 inches (25-50 mm) below the high point of the rubber surface of the HANS® device yoke. The HANS® device, with comfort padding, raises the effective height of the shoulders about 1 inch (25mm). Belt anchors may need to be adjusted to meet the installation guidelines outlined in this manual.

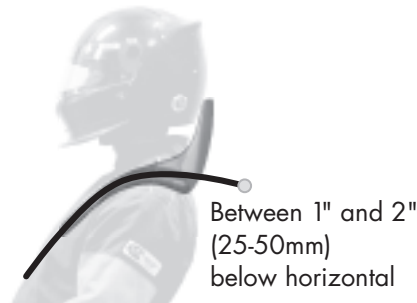

NOTE: Many chassis do not feature properly located shoulder harness mounts to begin with. These should be corrected for proper harness performance regardless of whether or not a HANS® device is being used.

CLEARANCE WITH SEATS AND HEAD PADDING

Your HANS® device should not contact your seat, headrest, or the bodywork around the cockpit opening. Many drivers have seats that contact their shoulders and head pads that contact their helmets. In such cases space must be made for the HANS® device. The HANS® device can be accommodated by reshaping the seat and/or the head padding. Remember, the driver moves during racing. Clearance of about 1.5" (40mm) between the helmet and seat should be provided so that the HANS® device can move on and with the user.

When checking for clearance it is important for the driver to move energetically in the seat to simulate the motions while racing. The HANS® device can also be shaken and moved by a helper. When most drivers tighten their shoulder belts while wearing the device the HANS® device is usually pulled forward. Movement by the driver usually moves the HANS® device back on the shoulders to a position that is more comfortable and into a space normally occupied by the seat head padding. Several attempts at trimming the seat or head padding may be required to achieve proper fit and comfort.

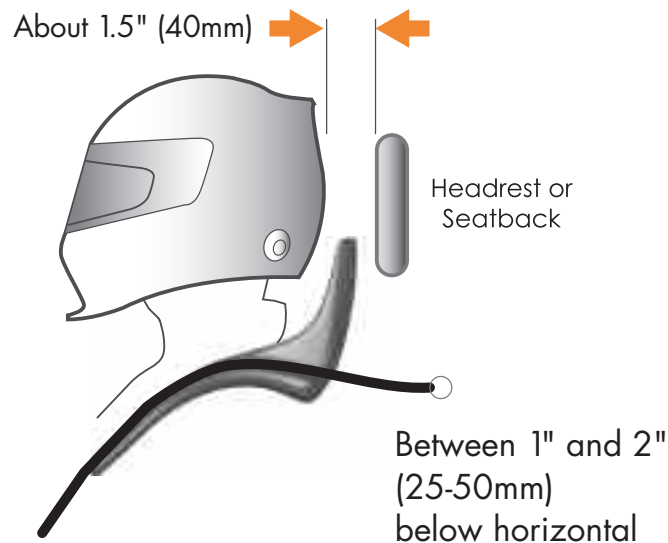

VEHICLE PREPARATION SUMMARY

- + Your shoulder harness anchors should be mounted such that the inside edges of the belts are not more than 3 inches (75 mm) apart. Less is better.
- + The shoulder harness anchors should be mounted close to the driver and between 1 and 2 inches (25-50 mm) below the top of the high point of the rubber surface of the yoke of the HANS® device.
- + The shoulder harness buckles should rest on the lower part of the HANS® carbon fiber collar.
- + You need some clearance – approximately 1-1/2 inches (40 mm) - between your helmet and the seat back or headrest of your vehicle.
- + The tethers of the device are installed to a pre-set length. You may lengthen or shorten the tethers up to 1 inch (25 mm) if you need more head movement for visibility. Most drivers find the original setting works well. Make sure that the tethers are routed properly.
- + You may change the padding for better fit and comfort but **NEVER MODIFY** the body of the HANS® itself! Do not heat, clamp in a vice, drill, cut, bend or otherwise try to alter the shape of the device. This will render the device ineffective if not dangerous!

Clearance of about 1.5" (40mm) between the helmet and seat should be provided so that the HANS® device can move on and with the user.

USING YOUR HANS® DEVICE

FITMENT

HANS® device model shapes have been refined to fit a wide range of drivers. The shape of the yoke and the angle of the collar relative to the yoke are the most significant aspects that affect driver fit and comfort.

The device yoke fits on top of the user's torso but under the shoulder harness straps so that the harness holds the device to the user's torso. The slot between the forward 'legs' of the yoke must be wide enough to slide the device onto the shoulders and around the neck, from the rear. The area to the sides and rear of the neck should be large enough to fit the user. The lateral edges of the yoke legs should not unduly interfere with the user's arms or shoulders, such as while crossing the arms during steering. The padded part of the yoke may rub against the driver's neck when putting it on. This padding is adjustable for comfort and fit. Comfort and interference can be properly evaluated only after the driver has run several laps at racing speed.



HELMET ANCHOR ATTACHMENT

OVERVIEW

The post-style attachment of the HANS® device to your helmet has been designed to be customer installed. Please note it is imperative that you follow the directions and use only – and all – parts supplied by HANS® Performance Products.



Failure to properly install the attachment hardware will prevent the device from working as it was designed and may result in injury or death.

OPERATION

To attach the HANS® device tethers to the helmet, place the large hole in the post-catch over the post on the helmet with the flats on the post-catch aligned with the flats on the post. The flats should be roughly parallel to the ground. While pushing in towards the helmet, slide the post-catch back toward the device until the small hole in the post-catch engages with the post on the helmet. Release the inward pressure on the post-catch and spring-loaded button, then tug on the tethers to make sure that the ends are positively attached. To remove, press in on the post-catch while sliding it forward and in line with the flats, away from the HANS® device. Release the pressure on the post-catch and let it fall away from the helmet.

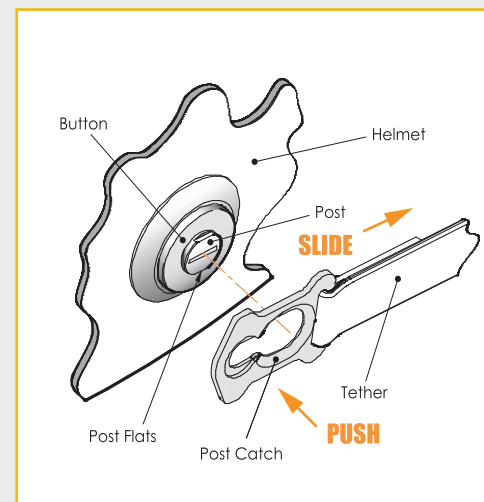

The HANS® device is unique in that it allows both safety and mobility. The device tethers bear the tremendous forces your neck would otherwise experience in a crash, yet are designed to allow ample head movement during regular driving and racing. The dual tether configuration maintains your head's alignment.



TETHER FUNCTION

In a crash the driver moves forward relative to the HANS® device, which is held in place by friction with the shoulder belts until the tethers come straight. The tethers then start to bear load and pull the device along with the head and helmet. When the loads in the shoulder belts restrain the torso, the device restrains the head relative to the torso. In this way the tethers are in tension before the torso and head are restrained and differences in tether length are not significant to performance of the device.

TETHER LENGTH

The most common question from new owners is “Are My Tethers Too Long?” The HANS® device is assembled with 6 inch (150mm) long tethers that are acceptable to most users. Measure this length from the front of the collar to the center of the hole provided for the helmet anchor. You should have a full side-to-side range of motion and be able to touch your chin to your chest with the device as delivered. Tether length can be adjusted plus or minus 1 inch (25mm) for individual preference. Tether length should be long enough to allow motions of the head and helmet that are needed by the driver, but no more. Several adjustments may be required to optimize the tether length to a driver. Different tether lengths may be desired for different cars or racetracks.

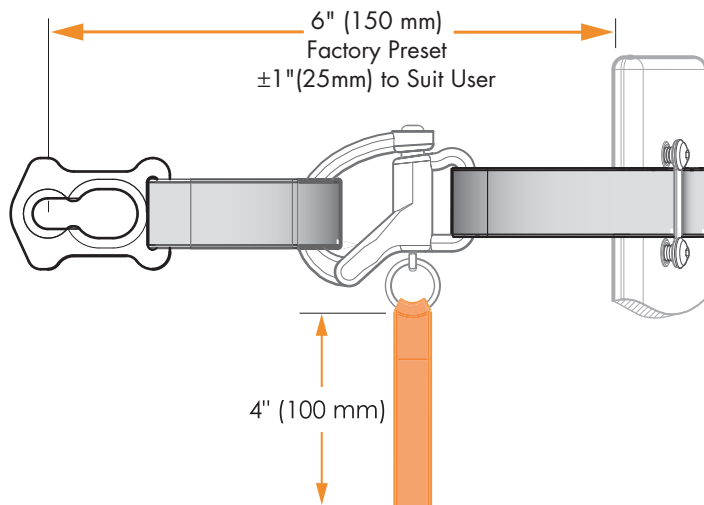

TETHER ADJUSTMENT

Loosen the screws on both tether clamps. Remove the two lower screws and rotate both clamps until the tethers are free. You can now adjust the tethers without removing the clamps. Note the routing of the tethers through the device – see graphic on next page or on front of device. Remove any slack and ensure the tethers are equal length. Tighten the screws holding the tether clamps until they are fully seated and taut.

Should you need to replace the tethers for any reason you must reroute the tethers correctly. Correct operation of the device and your safety depend on it.

QUICK DISCONNECT TETHERS

Also known as QD's, these are for immediate release of the helmet from the device. This is a popular option with many drivers who operate in a confined space. The QD tethers allow greater convenience and flexibility when entering and exiting your vehicle, and when attaching your helmet.



QUICK DISCONNECT OPERATION

QD OPERATION

To operate the quick-disconnects, attach the post-catches as illustrated above. When seated and belted in your car with your helmet and device on, practice grabbing the release straps. We have provided extra length for your preference but be certain that the release straps hang free when you are driving. Unless you have other methods of keeping the straps out of the way, we suggest they be cut

to about 4 inches (100mm) and let them dangle. To disconnect, lean your head forward to put tension on the tethers. Take hold of both release straps and pull them down, shaking your head slightly. Your head and helmet will be released from the device immediately. Two post-catch loops will remain on the helmet. We suggest practicing this until you become familiar with the operation. To reinstall the quick-disconnects, place the short loop (post-catch loop) attached to the helmet back in the shackle – do not twist – and close the shackle. Make sure that the shackle is fully closed. Ensure that the dangling orange release straps do not become pinched, pulled, tangled, trapped, or otherwise captured in your shoulder harness, helmet, HANS® device, seat or anything else. These should hang free!

A strap that is not hanging free could release your helmet from the device by accident creating an unsafe situation.

TETHER ROUTING

When adjusting the tether length or installing new tethers, make sure that the tether is routed per the diagram at the right. The tethers pass along the front side of the collar and back through the slot that is further from the centerline. The free end of the tether extends around the side edge of the collar and can be tucked back under the padding against the collar. In this way, the tether from the helmet bears against the free end and holds it from sliding on the collar when loaded.

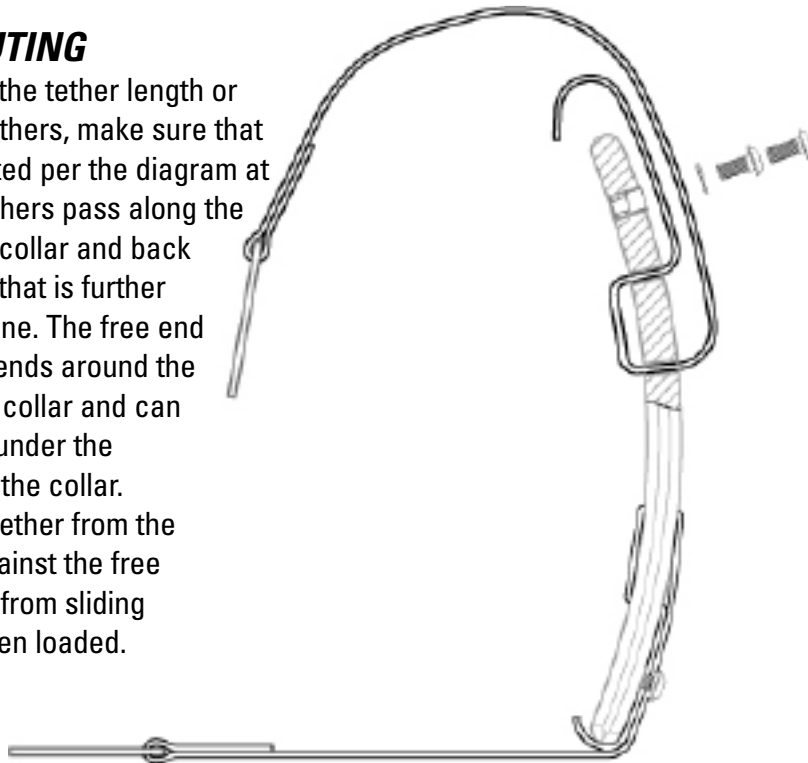

It may take a few laps to get used to the device but most drivers soon forget that they are wearing their HANS® device.

USING YOUR HANS® DEVICE SUMMARY

- + **To put the device on, slide the device forward onto your shoulders allowing the carbon fiber yoke to straddle your neck and rest on the upper portion of your chest.**
- + **The device should sit comfortably on your chest and shoulders without digging into your body when you are in your racing seat.**
- + **Make sure there is space in your seat and cockpit for the HANS® device. Even if it is comfortable when you try the device on outside of the vehicle, true fit cannot be judged until you are strapped into your vehicle as you would be during a race.**
- + **Depending on your vehicle and the ease of entry, you can put on the device before or after entering the cockpit. Once inside, put on your harness as usual, making sure that the shoulder belts run over the rubber surfaces on the top of the device on each side of your neck. The belts need not cover the collar entirely but should cover at least half the collar on each side. You may need to lengthen your upper shoulder belts. Some minor movement is normal.**
- + **Verify that you have sufficient freedom of movement to operate all controls, view the road ahead and to the side, and view the instrument panel. The device should not cause any discomfort or force you into an unnatural seating position. While seated normally you should have 45° of head movement to both the right and left; you should have nearly the same movement up and down as you would without the device.**

MAINTENANCE OF YOUR HANS® DEVICE

The HANS® device is made of extremely durable materials, however there are a few simple steps that are recommended to keep your device in peak operating condition for many seasons of racing.

One of the most important mechanisms of the device is the friction between the shoulder harness and the rubber covering of the yoke. Keep the rubber clean. Long term exposure to dirt, sand, metal shavings and other foreign debris will cause your device to wear prematurely and may compromise the performance of the device. Worn friction material can be replaced by HANS® Performance Products. Contact us for details.

The tether material is very robust. However, if your device has experienced even a moderate crash, we recommend that you replace your tethers. Throughout your racing season inspect the tethers for fraying or chafing. If you observe wear, replace the tethers. The tethers can be susceptible to degradation from ultraviolet exposure. For this reason we recommend keeping your device out of direct sunlight when not in use. In any event, tether replacement is recommended at least every two years.

The attachment hardware should be kept clean and free of dirt and grit for best performance and long life.

Regular visual inspection of your device and the mounting points on your helmet are necessary to insure peak performance of your HANS® device. Excessive wear or damage to any of the components of the device should not go unchecked. Worn or damaged parts should be replaced before the device is used again. Attachment hardware for tethers, pads, and helmets are easily replaced by the customer using parts purchased from HANS® Performance Products.





FREQUENTLY ASKED QUESTIONS

What type of shoulder belts work best with my HANS® device?

As the inventors, developers and only marketers of HANS® devices worldwide, we recommend any 3" (75mm) SFI or FIA certified belt system for use with HANS® devices. Based upon better stretch and aging characteristics, we prefer that drivers use polyester belts. However, both nylon and polyester work fine with HANS® devices.

My belts sometimes slip off my device. What's wrong?

Properly mounted belts do not slip off the device. If your shoulder belts will not stay securely over the device when you are firmly belted in chances are that you do not have the shoulder belt mounts properly located in your chassis.

Do I need a different HANS® device for each helmet?

No. As long as each helmet is fitted with the proper anchors, you can use one HANS® with multiple helmets.

Can I share my HANS® device?

Provided that you are of similar physical size and shape to your partner, and you are sharing the same cockpit or similar seating applications, chances are good that you can share a device. Both of you will need to have HANS® anchors installed on your helmets.

What is the difference between the Economy and Professional models?

The only functional difference between these models is weight. The Professional model is 100% carbon fiber to reduce weight as much as possible.

Can I wear a "horse collar" foam pad with my HANS® device?

Yes. Note testing has shown a horse collar adds weight to the helmet and the head that must be carried by the neck and the HANS® device. This increases the chance of injury. Wear one for comfort, not safety related reasons.

When I put my device on, it rubs against my neck. Is that normal?

Yes, so long as this only occurs when putting on the device. This is a compromise to allow the driver to have greater clearance for steering and other arm movement.

Do I need a special helmet?

No. The helmet anchors fit any Snell™, SFI, FIA 8858-2002 or FIA 8860-2004 approved racing helmet.

I can touch my chin to my chest with the device on. Is this a problem?

No. The HANS® tethers offer a great deal of mobility while still reducing the chance of injury. In an actual impact, the HANS® will remain stationary with respect to the shoulder belts, while your body slides forward until the tethers straighten. (Your head will not swing down towards your chest). The slack in the tethers is taken up before the belts restrain the torso, the HANS®, and the head together.

What if my HANS® device is in an impact?

Like all driver safety equipment, HANS® devices should always be inspected after an accident. In a simple self-inspection, users should look for signs of de-lamination or surface cracking and exposed composite material under the finish. However, even the most thorough visual inspection and strength testing can fail to detect damage. This is one of the reasons that we do not resell used devices, and we do not recommend that anyone buy a used device. If in doubt about the integrity of a HANS® device, it should be replaced.

Like all driver safety equipment, HANS® devices should always be inspected after an accident.



When should I replace my HANS® device?

Snell recommends replacing competition helmets every five years. HANS® devices are made with similar high-performance composite materials and resins. They are also exposed to similar environments. Snell's five-year rule for helmets is only a guideline, but it is one that we think users should consider when reviewing the integrity of a HANS® device. Auto racing is dangerous, and the consequences of auto racing accidents can be violent and permanent. As a result, only HANS® devices that are in top condition should be worn in competition. The form of racing in which a user competes may also dictate the timeframe for replacing a HANS® device, especially if a user competes in open cockpit environments. Even the best materials deteriorate over time. Further, we recommend users replace their HANS® device if it is involved in an accident or shows any signs of structural damage.



Can I buy parts and support for my HANS® device?

For devices purchased in the past 3 years, yes. However we do not support the older models of HANS® devices or helmet anchors.

How do I care for my HANS® device?

HANS® devices should be kept clean and dry. Extreme hot or cold environments should be avoided. They should be kept away from petroleum products or other corrosives as these can have unexpected results on even the strongest composite materials and resins. To protect them, devices should be stored out of direct sunlight or in a bag. They may be cleaned with soapy warm water.

Does a HANS® device cause my head to stop too quickly in an accident? That is to say, is it more likely that my brain could be injured by slamming into the inside of the front of my skull when wearing a HANS® device?

No. While the brain is not securely fastened to the skull except across the lower brain where there are major nerves and blood vessels through the base of the skull, the brain is not free to move because it is filled with and surrounded by fluid (primarily water). The least possible motions of the brain relative to the skull are straight-line motions, while rotary motions are more possible. The brain in the skull is somewhat like one of those winter scene globes with the "snow" in it. If you move it quickly in a straight line, the snow does not fly. On the other hand, if you rotate it quickly, you get a snowstorm. Sudden head rotation may be more dangerous than straight-line motion. The major action of the HANS® device is to reduce the swinging motions of the head. This does two things: it reduces the stretch of the neck which otherwise could cause a basal skull fracture; and, it reduces the rotation of the head, which could otherwise cause a brain injury.

A few drivers have reported some discomfort in the front of their heads after a big hit with the HANS® but this quickly resolves. The medical people in racing say that this is minor relative to what would have happened without the device. In the study of racing safety, we have learned that loads and accelerations on the driver are best reduced by temporarily coupling the body as well as possible to the chassis. While it may be possible to reduce peak loads in some cases by adding some cushion or compliance to the restraints, this generally leads to higher loads on people because it allows a larger difference in velocity between the driver and the chassis before the driver is restrained. In the case of the HANS® device, there is a lot of compliance in the restraint belt and body; we do not need to add more compliance.

HANS® devices should be kept clean and dry. Extreme hot or cold environments should be avoided.





GLOSSARY

Button – A component of the post anchor assembly that deflects down, when pushed, allowing the post clamp to slide into the engaged position.

Collar – The part of the HANS® device that the tethers attach to. It sticks up behind the user's neck. The angle between the yoke and the collar determines the model series of the device and should roughly correspond to the seat back recline angle (from vertical) of the vehicle in which the device will be worn.

FIA – Federation Internationale de L'Automobile
An organization that establishes standards and specifications for world motorsport.

Helmet Centerline – The longitudinal (fore/aft) geometric center of the helmet, used for locating the helmet attachment points.

Neck Size – Also referred to as shirt collar size, the circumference of the driver's neck, used to specify the size HANS® device.

Post Anchor – A spring loaded, post-shaped anchor bolted to the helmet for attaching the HANS® device tethers.

Post-catch – The metal component on the end of the tether that attaches to the post.

Post Retaining Nut – The large, disc-shaped, threaded component of the post anchor that is inserted inside the helmet between the shell and liner.

Quick Disconnect Tether – Also referred to as QD's, an optional tether assembly that includes shackles. The driver simply pulls the colored release straps and the helmet is immediately detached from the HANS® device.

QD – Abbreviation for Quick Disconnect used to describe optional tethers.

Release Straps – Smaller ribbons that open the QD shackles, usually orange in color.

Rubber – the topmost covering on the HANS® device yoke.

Shackle – A robust, spring-loaded device in the middle of the quick disconnect tether assembly.

Snell – The Snell Memorial Foundation establishes standards and specifications for helmet performance.

SFI – The SFI Foundation establishes standards and specifications for safety products.

Tether – The straps running from the HANS® device to the helmet.

Tether Clamp – The clamp that secures the tethers to the collar of the device.

Yoke – The part of the HANS® device that runs down the chest of the user on the left and right side of the neck.

Yoke & Collar Pads – The padded components of the HANS® device, attached by Velcro™, used for driver comfort. The HANS® device will function properly without them and they may be modified by the user.

